

UniStream™ HMI Panel

Installation Guide USP-070-B10 and USP-104-B10

Unitronics' UniStream™ platform comprises control devices that provide robust, flexible solutions for industrial automation.

This guide provides basic installation information for the UniStream™ HMI Panel.

Technical specifications may be downloaded from the Unitronics website.

The UniStream™ platform comprises CPU controllers, HMI panels, and local I/O modules that snap together to form an all-in-one Programmable Logic Controller (PLC).

Expand the I/O configuration using a Local Expansion Kit or remotely via CANbus.



UniStream™
HMI Panel



UniStream™
CPU-for-Panel

Uni-I/O™
Modules

CPU-for-Panel CPUs are Programmable Logic Controllers (PLCs), the heart of the UniStream™ platform. The CPU-for-Panel cannot operate independently. It must be plugged into the back of a UniStream™ HMI panel. The panel provides the CPU's power source. The CPU-for-Panel comprises:

- IO/COM Bus connector for interfacing Uni-I/O™ & Uni-COM™ modules
- Isolated RS485 and CANbus ports
- Backup battery

HMI Panels Available in different dimensions A high-resolution touch screen provides the operator interface for the system and the physical foundation for a PLC+HMI+I/Os all-in-one controller.

The DIN-rail structure on the panel's back is designed to physically support a CPU-for-Panel controller, Uni-I/O™ and/or Uni-COM™ modules.

Each panel comprises:

- AUX connector to support the CPU
- 1 audio-out 3.5mm jack
- 1 microSD slot
- 2 type A, USB host ports and 1 Mini-B USB device port
- 2 Ethernet ports, RJ45, 10/100 Mbps
- 1 power input connector, 12/24 VDC

I/O Options Integrate I/Os into your system by using:

- On-board I/Os: snap onto the panel for an all-in-one configuration
- Local I/O via a Local Expansion Kit
- Remote I/O via EX-RC1

Programming Software All-in-one UniLogic™ software, for hardware configuration, communications, and HMI/PLC applications, available as a free download from Unitronics web site.

Use of this product is subject to a Unitronics Controller License Agreement, a copy of which can be found at http://unitronics.com/unistream/Agreements/Unit_lc1.pdf

Before You Begin



Before installing the device, the installer must:

- Read and understand this document.
- Verify the Kit Contents.

Note that the CPU-for-Panel is intended to be installed on the back of an HMI panel in accordance to a separate installation guide supplied with the CPU-for-Panel.

Alert Symbols and General Restrictions

When any of the following symbols appear, read the associated information carefully.

<i>Symbol</i>	<i>Meaning</i>	<i>Description</i>
	<i>Danger</i>	<i>The identified danger causes physical and property damage.</i>
	<i>Warning</i>	<i>The identified danger could cause physical and property damage.</i>
<i>Caution</i>	<i>Caution</i>	<i>Use caution.</i>

- All examples and diagrams are intended to aid understanding, and do not guarantee operation. Unitronics accepts no responsibility for actual use of this product based on these examples.
- Please dispose of this product according to local and national standards and regulations.
- This product should be installed only by qualified personnel.

-  Failure to comply with appropriate safety guidelines can cause severe injury or property damage.
- Do not attempt to use this device with parameters that exceed permissible levels.
- Do not connect/disconnect the device when power is on.

Environmental Considerations

-  Ventilation: 10mm (0.4") of space is required between the device top/bottom edges and the enclosure's walls.
- Do not install in areas with: excessive or conductive dust, corrosive or flammable gas, moisture or rain, excessive heat, regular impact shocks or excessive vibration, in accordance with the standards and limitations given in the product's technical specification sheet.
- Do not place in water or let water leak onto the unit.
- Do not allow debris to fall inside the unit during installation.
- Install at maximum distance from high-voltage cables and power equipment.

- Caution* ▪ The UniStream™ HMI Panel is designed to comply with NEMA-4X, IP66 and IP65. Note however that the Audio Protection Seal must remain plugged in for NEMA-4X and IP66, in which case the audio sound level from the internal speaker is significantly reduced.

Kit Contents

- 1 HMI Panel: 7" or 10.4"
 - 7" panel, includes 4 mounting brackets
 - 10.4" panel, includes 8 mounting brackets and 2 panel supports
- 1 panel mounting seal
- 1 programming cable
- 1 power terminal block

HMI Panel Diagram

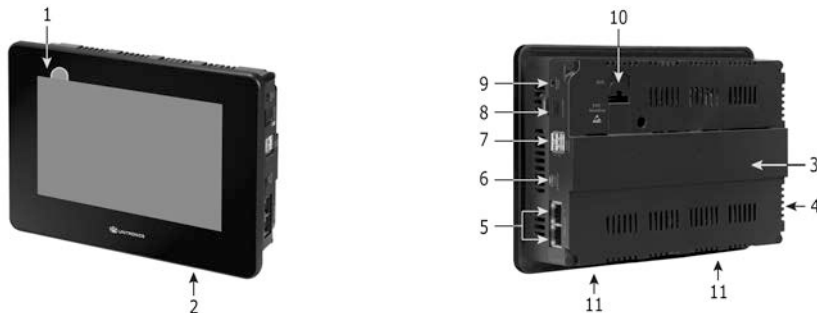

HMI Panel Front and Rear View

1	Screen Protection	A plastic sheet attached to the HMI Panel screen for protection. Remove it during installation of the HMI Panel.
2	Audio Outlet Seal	Prevents dust accumulation in the small outlet that serves the HMI panel's embedded speaker.

Caution ▪ Keep the seal in place when the embedded speaker is not used. The seal must be kept in place for IP66 and NEMA-4X compliance.

3	DIN-rail structure	Physical support for the CPU-for-Panel, Uni-I/O™ and/or Uni-COM™ modules.
4	12/24VDC power input	Connection point for the HMI Panel's power source. Connect the Terminal Block supplied with the kit to the end of the power cable.
5	2 Ethernet (RJ45) ports	Support high-speed Ethernet communications.
6	USB Device	Use for application download and direct PC-UniStream communication.
7	2 USB Host ports	Provide the interface for external USB devices.
8	microSD slot	Supports standard microSD cards.
9	Audio-out jack	In addition to the HMI Panel's embedded speaker outlet, this 3.5mm Audio-out jack enables you to connect external amplifiers and speakers.
10	Auxiliary connector (AUX)	Provides the electrical connection for the CPU-for-Panel.
11	Support Slots	Snap the supports (supplied with 10.4" panel only) into these slots, to hold it upright on a desk while programming.

Installation Space Considerations

Allocate space for:

- The HMI Panel including the CPU and any modules that will be installed on it
- Opening the doors of the CPU and modules

For exact dimensions, please refer to the Mechanical Dimensions shown below.

HMI Panel Mechanical Dimensions

7" Panel

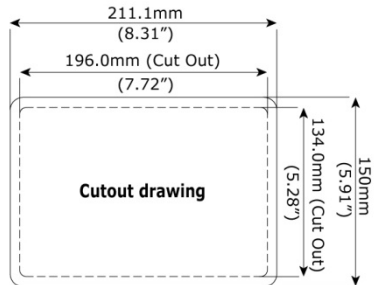
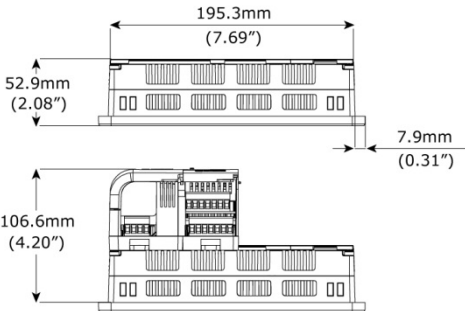
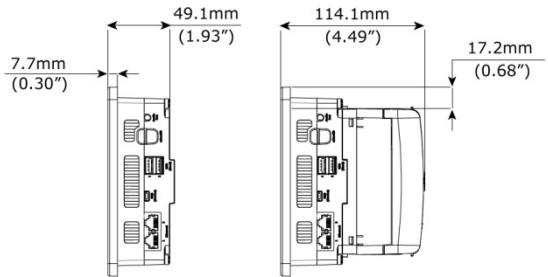
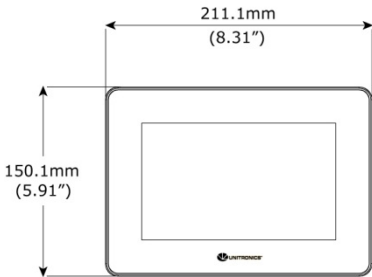

10.4" Panel

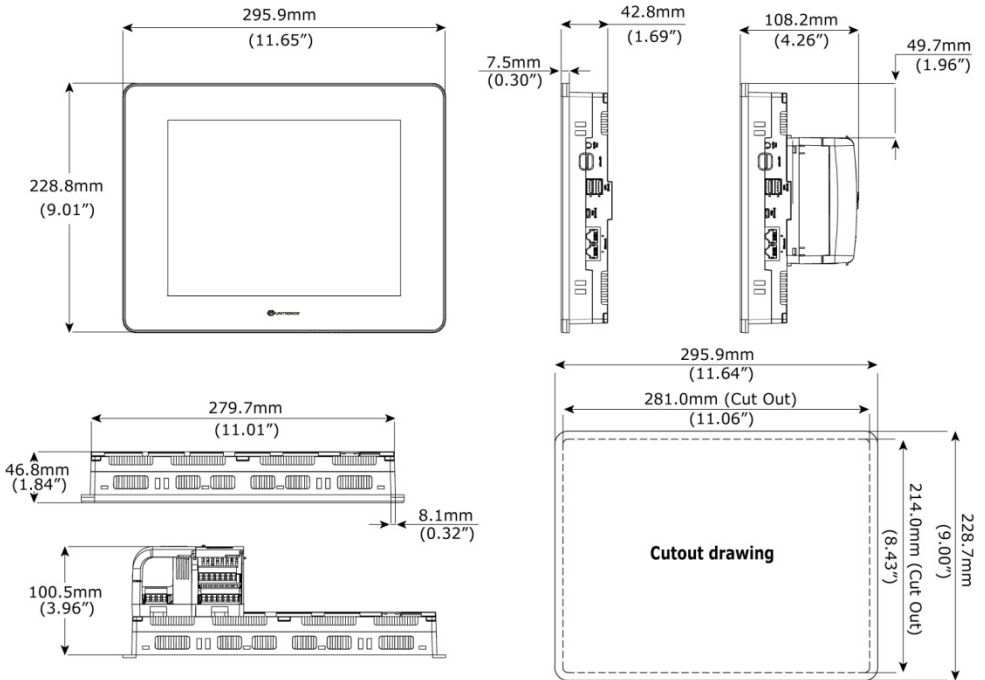

Panel Mounting

- NOTE**
- Mounting panel thickness must be less or equal to 5mm (0.2").
 - Ensure that the space considerations are met.

1. Prepare a panel cut-out according to the dimensions of your model, USP-070-B10 or USP-104-B10, as shown in the previous section.
2. Slide the panel into the cut-out, ensuring that the Panel Mounting Seal is in place as shown on the right.
3. Push the mounting brackets into their slots on the sides of the panel as shown below.
4. Tighten the bracket screws against the panel. Hold the brackets securely against the unit while tightening the screws.

When properly mounted, the panel is squarely situated in the panel cut-out as shown below.

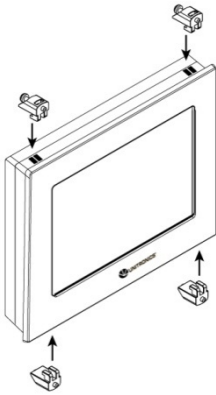
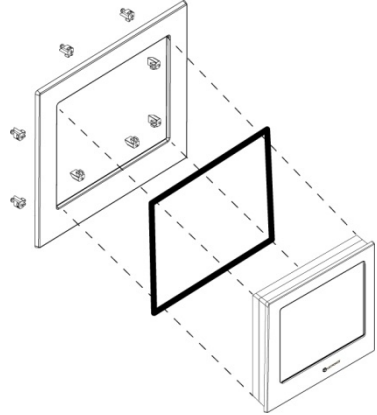

USP-070-B10: 4 mounting brackets

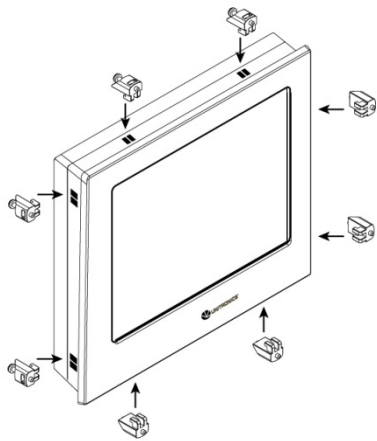

USP-104-B10: 8 mounting brackets

Wiring



- This equipment is designed to operate only at SELV/PELV/Class 2/Limited Power environments.
- All power supplies in the system must include double insulation. Power supply outputs must be rated as SELV/PELV/Class 2/Limited Power.
- Do not connect either the 'Neutral' or 'Line' signal of the 110/220VAC to device's 0V point.
- Do not touch live wires.
- All wiring activities should be performed while power is OFF.
- Use over-current protection, such as a fuse or circuit breaker, to avoid excessive currents into the HMI Panel supply port.
- Unused points should not be connected (unless otherwise specified). Ignoring this directive may damage the device.
- Double-check all wiring before turning on the power supply.

- Caution**
- To avoid damaging the wire, use a maximum torque of 0.5 N·m (5 kgf·cm).
 - Do not use tin, solder, or any substance on stripped wire that might cause the wire strand to break.
 - Install at maximum distance from high-voltage cables and power equipment.

Wiring Procedure

Use crimp terminals for wiring; use 26-12 AWG wire (0.13 mm² –3.31 mm²).

1. Strip the wire to a length of 7±0.5mm (0.250–0.300 inches).
2. Unscrew the terminal to its widest position before inserting a wire.
3. Insert the wire completely into the terminal to ensure a proper connection.
4. Tighten enough to keep the wire from pulling free.

Wiring Guidelines

In order to ensure that the device will operate properly and to avoid electromagnetic interference:

- Use a metal cabinet. Make sure the cabinet and its doors are properly earthed.
- Use wires that are properly sized for the load.
- Individually connect each 0V point in the system to the power supply 0V terminal.
- Individually connect each functional ground point (⚡) to the earth of the system (preferably to the metal cabinet chassis).
Use the shortest and thickest wires possible: less than 1m (3.3') in length, minimum thickness 14 AWG (2 mm²).
- Connect the power supply 0V to the earth of the system.

NOTE For detailed information, refer to the document System Wiring Guidelines, located in the Technical Library in the Unitronics' website.

Wiring the Power Supply

The UniStream™ HMI Panel device requires an external 12/24VDC power supply.



- In the event of voltage fluctuations or non-conformity to voltage power supply specifications, connect the device to a regulated power supply.

Connect the +V and 0V terminals as shown in the accompanying figure.

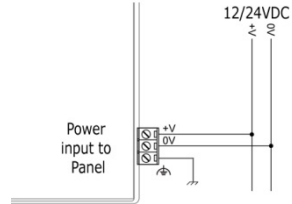

HMI Panel Interface Connections

Use the following:

Ethernet	CAT-5e shielded cable with RJ45 connector
USB Device	Use the proprietary programming cable supplied with the device
USB Host	Standard USB cable with Type-A plug
microSD	Standard microSD
Audio Out	3.5mm stereo audio plug with shielded audio cable

Installing CPU-for-Panel, Uni-I/O™ & Uni-COM™ Modules

Refer to the Installation Guides provided with these modules.



- Turn off system power before connecting or disconnecting any modules or devices.
- Use proper precautions to prevent Electro-Static Discharge (ESD).

Removing the Panel

1. Disconnect the power supply.
2. Remove all wiring and disconnect any installed devices according to the device's installation guide.
3. Unscrew and remove the mounting brackets, taking care to support the panel to prevent it from falling during this procedure.

The information in this document reflects products at the date of printing. Unitronics reserves the right, subject to all applicable laws, at any time, at its sole discretion, and without notice, to discontinue or change the features, designs, materials and other specifications of its products, and to either permanently or temporarily withdraw any of the foregoing from the market.

All information in this document is provided "as is" without warranty of any kind, either expressed or implied, including but not limited to any implied warranties of merchantability, fitness for a particular purpose, or non-infringement. Unitronics assumes no responsibility for errors or omissions in the information presented in this document. In no event shall Unitronics be liable for any special, incidental, indirect or consequential damages of any kind, or any damages whatsoever arising out of or in connection with the use or performance of this information.

The tradenames, trademarks, logos and service marks presented in this document, including their design, are the property of Unitronics (1989) (R'G) Ltd. or other third parties and you are not permitted to use them without the prior written consent of Unitronics or such third party as may own them.

[DOC21001-A4] 07/13